

GHHP-2019-045

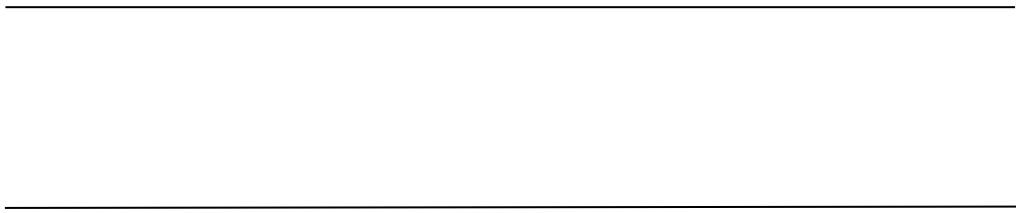

1	1
2	4
2.1	4
2.2	6
2.3	6
2.4	6
3	7
3.1	" " 	7
3.1.1	7
3.1.2	" " 	8
3.2	11
3.3	11
3.3.1	11
3.3.2	17
3.3.3	19
3.3.4	20
3.4	21
3.4.1	22
3.4.2	22
3.5	22
4	27
4.1	27
4.1.1	27
4.1.2	29
4.1.3	32
4.1.4	32
4.2	" " 	33
4.2.1	" " " " 	33
4.2.2	" " 	33
5	37
5.1	37
5.1.1	37
5.1.2	37
5.2	38
5.2.1	38
5.3	39
5.3.1	3
9	
5.3.2	42
6	45
6.1	45
6.2	45
6.3	46

	6.4	46
7		48
	7.1	48
	7.2	49
	7.2.1	49
	7.2.2	49
	7.3	49
	7.4	50
8		51
	8.1	51
	8.2	51
	8.3	51
	8.4	52
	8.5	52
9		56
	9.1	56
	9.2	56
	9.2.1	56
	9.2.2	68
10		74
	10.1	74
	10.2	74
	10.3	74
	10.4	75
	10.5	75
	10.5.1	75
	10.5.2	75
	10.6	76
	10.7	76
11		81
	11.1	81
	11.1.1	81
	11.1.2 "	81
	11.1.3	81
	11.1.4	82
	11.1.5	82
	11.1.6	83
	11.2	85

		[20
	12] 3	
		[2012]8
		[2014]2
		[2015]7
		[2016]17

1	
2	
3	

1	" "
---	-----

1

()

) () () [()]

2002 6

" PVC "

2003 1

" PVC "

2005 8 31

2003 12

" "

2005 1

2005 8 31

2009 6

" "

[2009]100

2014 1

2014 1 29

[2014]005

57000

186671

2012 10 31

[2012] 3 2012 9

2012 10 26

[2012]8

E101 E201 E301

" + +15

" " + " " +

+MBR "

2014 1

682

<

> ([2017]4

2019 2

2019 3 2

2019 3 21 22

2

2.1

1 1989 12 26
2014 4 24

2015 1 1

2 1984 5 11
1996 5 15 200

8 2 28 2017 6 27 2018 1 1

3 1987 9 5
1995 8 29

2000 4 29 2015 8 29 201

6 1 1 2018 10 26

4 1996 10 29

1997 2018 12 29

5 1995 10 30
2004 12 2

9 2013 6 29 2015 4 24

11 23

8

2018 5 16

2012 1 12

2018 3 28

2018

5 16

9

2009 9 23

2012 1 12

2017 6 3

2018 3 28

2018 5 16

10

1998 11 29

253

2017 7 16

682

2017 10 1

11

<

>

[2017]4

12

[2017]1235

13

[2015]113

14

[2

018]34

15

[97]122

16

[2018] 6

17

[201

5]256

2.2

1

2012 9

2 <

> [201

2]8 2012 10 26

3

2015 5

4 <

> [20

15]7 2015 8 4

2.3

1

HJ792-201

6

2 < >

2018 9 2018 5 15

3

HJ/T 397-2007

4

HJ/T 91-2002

5

HJ 819-2017

2.4

1

2

2016 5

3

3

3.1 " "

3.1.1

1 PVC

2003 1

" PVC "

2005 8 31

2

2003 12 "

"

2005 1

2005 8 31

3

2009 6 "

"

[2009]100

2014 1

2014 1 29

[2014]005

4

2017 10 "

"

[2017]99

2017 11

2018 12

3-1

3.1.2

“

”

3-1

1	PVC	PVC 100 /a	2003 1 14	2002 6	2005 8 31
2		5000 /a	2003 12 22	2004 1 2005 1	2005 8 31
		2000 /a			
		50 /a			
		1000 /a			
		500 /a			
3		A 3000 /a	2009 6 4	2009 7 2014 1	2014 1 29 [2014]005
		B, 2500 /a			
		C, 1500 /a			
		D, 1500 /a			
		A, 400 /a			
		B, 500 /a			
		C, 500 /a			
		D, 200 /a			
		A 100 /a			

		B, 100 /a				
4		4.8 /a	2017 10 27 [2017]99	2017 11 2019 4		
		3.2 /a				
		3.2 /a				
		2.0 /a				
		10.8 /a				
		6.0 /a				
		10.0 /a				

3.2

99

118° 88' 65"

32° 14' 05"

3

E101 E201

	15	500
	980	15kg 260kg
201 E301		E101 E

3-3

			h
	100 /a		2000
	100 /a		
	200 /a		
	100 /a		
	200 /a		
	30 /a		
	300 /a		
	300 /a		
	50 /a		
	100 /a		
	5kg/a	E201	
	5kg/a	E101	
	5kg/a		
	10kg/a	E301	
	250kg/a		



The diagram consists of two parallel horizontal lines. The top line is a single continuous line. The bottom line is also a single continuous line, positioned directly below the top line. Five vertical tick marks of equal length extend downwards from the bottom line, dividing the space between the two lines into six distinct sections of varying widths.

--	--	--	--	--	--

					/
		+	+ + MBR	+ MBR	
			" "	" "	
					/
		31047m ²			/

3.3.2

3-5

3-5

		/			
1		RET B S 25	1	1	/
2		EURO-ST D S25	1	1	/
3		T18BS25	1	1	/
4		YB-2	1	1	/
5		PL303	3	3	/
6		ZB-1E	1	1	/
7		FT-200AE	2	2	/
8		ZS-2E	1	1	/
9		HB43-S	1	1	/
10		/	1	1	/
11		YP10K-1	2	2	/
12		PL602-L	1	1	/
13		LGJ-50PLC	1	1	/
14		DP30A	1	1	/
15		DHG-9203A	1	1	/
16		HS-20D	1	1	/
17		UNI LAB-05- TJ	1	1	/

18

		/			
21		Agilent 1200	1	1	/
22		LC-20A	10	10	/
23		Agilent1260	20	5	/
24		XP205DR	2	2	/

2

/			
HWCL-5	1	1	/
DJ-1	4	4	/
SHB-	1	1	/
R201D	2	2	/
/	2	2	/
R201D	2	2	/
SHB-	1	1	/
ZKC-A	1	1	/

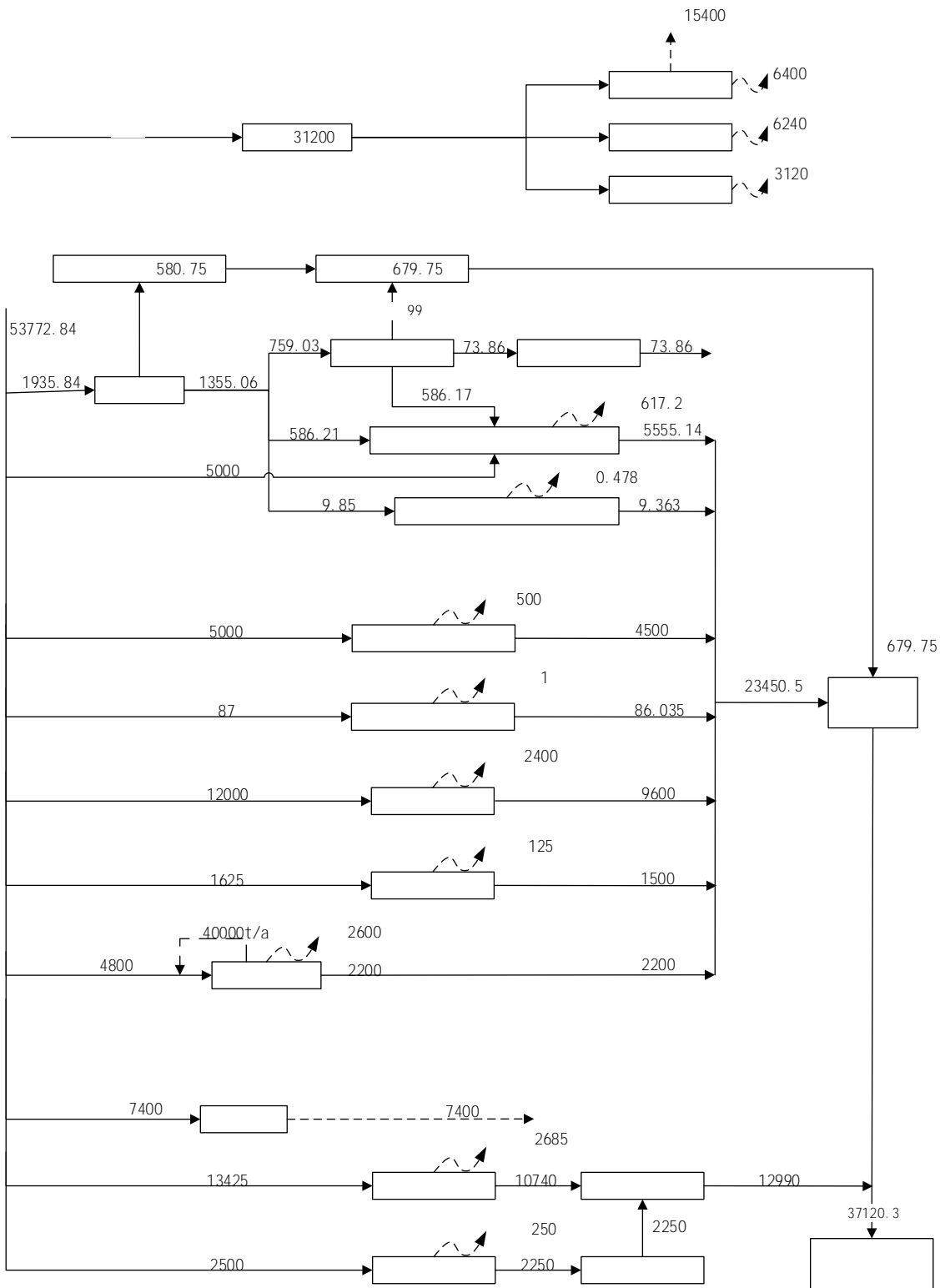

3-1

t/a

3.4

E101 E201 E301

3

100t/d

150t/d

MBR

6

MBR

100t/d

150t/d

37120.3t/a

3-7

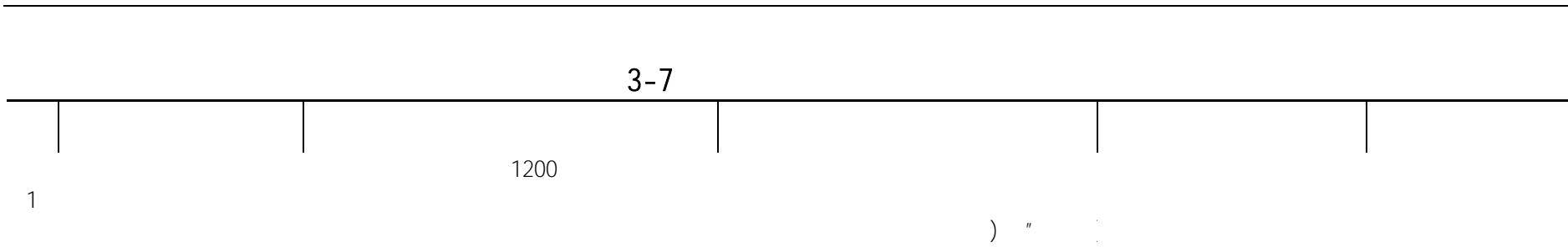

[2018]6

2.

[2015]256

3-8

3-9

3-8

[2018]6

50%

1

4-1

				t/a					
					10054.8				
			COD SS		95.398				
					9600				
			pH COD SS		500				
			COD SS		679.75				
			COD SS		10740				
			COD SS		2250				

4.1.2

3

1 30

1

4-2

4-2

4-2

					/		/	
							90%	30
							60%	10cm

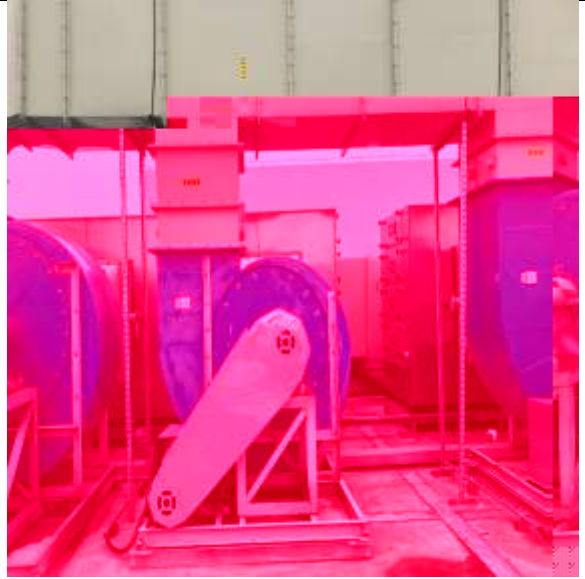

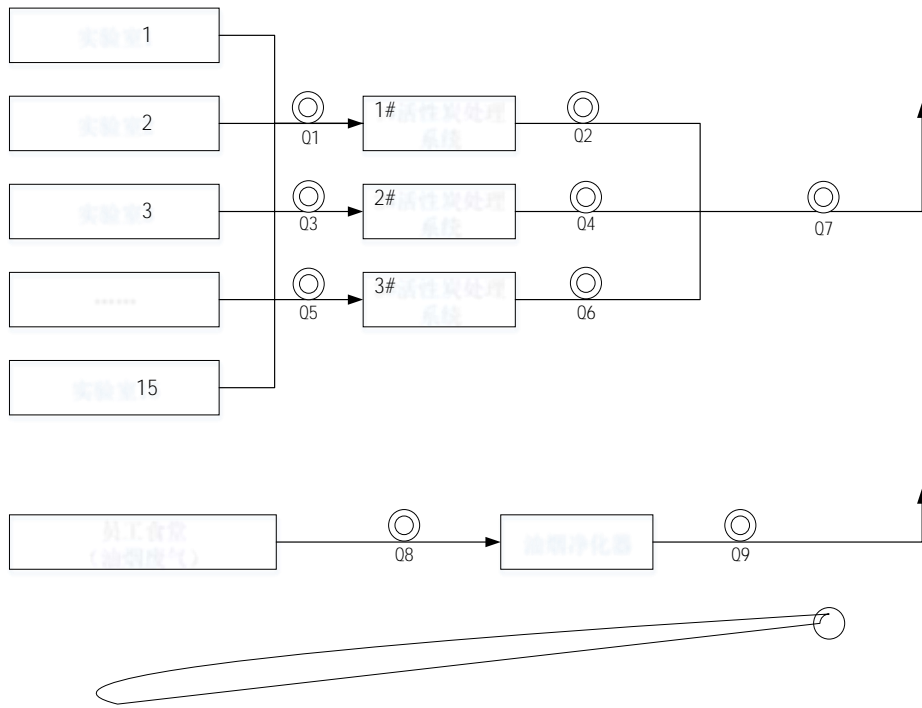

4-2

4.1.3

4-4

4-4

			/			t/a			
				HW49					
				900-					
				047-					

4-5

		pH COD SS	+	+ +MBR	+ +MBR	580	
				+ +	+ +	155	
		HCL				205	
						5	
						0	
						5	
						5	

						10	
						10	
					[97]122		
						1075	

5

5.1

5.1.1

5.1.2

1

2

3

4



" + +15
"

280

5.7

6

500

980

15kg

260kg

1

"

"



GB18597-2001)

5

2

6

100m

7

(GB12532-90)

15

8

DB32139-96)

24733t/a, COD 7.35t/a SS 6.15t/a
 0.36t/a 0.06t/a, COD 2,47t/a SS 1,73t
 /a 0.36t/a 0.01t/a, 0.006
 t/a 0.006t/a 0.08kg/a HCl 0.03kg/a 0.025k
 g/a

" "

5

5.3.2

2012 8)

1

186671m

60000m)

(GB18597-2001)

5

50

6

([97]122

7

24739

COD 7.35

NH₃-N 0.36

COD

2.47

NH₃-N 0.36

" "

3

5

"

2012 8 "

6

6.1

6-1

6-1

	mg/L, pH	
pH	6-9	
	500	
	400	
	35	
	3.0	

6.2

3

1 30

2

0

200

5

6-2

	(kg/h)			(mg/m ³)	
	(mg/m ³)	H ₁ =30m	H ₂ =30m		
	190	29	14.5	12	GB16297-1996 2
	100	1.4	0.7	0.20	
	261	0.3	/	/	

GB16297-1996

200m

5m

50%

H₁=30m

H₂=30m

50%

6-3

	mg/m ³	%			
	2.0	60	75	85	GB18483-2001

6.3

GB1234

8-2008 3

6-4

6-4

	Leq dB A	
	65	GB12348-2008 3
	55	

6.4

[2012]8

[2015]7

6-5

6-5

		24739 t	24739 t
	COD	7.35 t/a	2.47 t/a
	SS	6.15 t/a	1.73 t/a
		0.36 t/a	0.36 t/a
		0.06 t/a	0.01 t/a
		0.006 t/a	0.006 t/a
		0.006 t/a	0.006 t/a
		0.08 kg/a	0.08 kg/a
		0.03 kg/a	0.03 kg/a
		0.025 kg/a	

7

E101 E201 E301

7.1

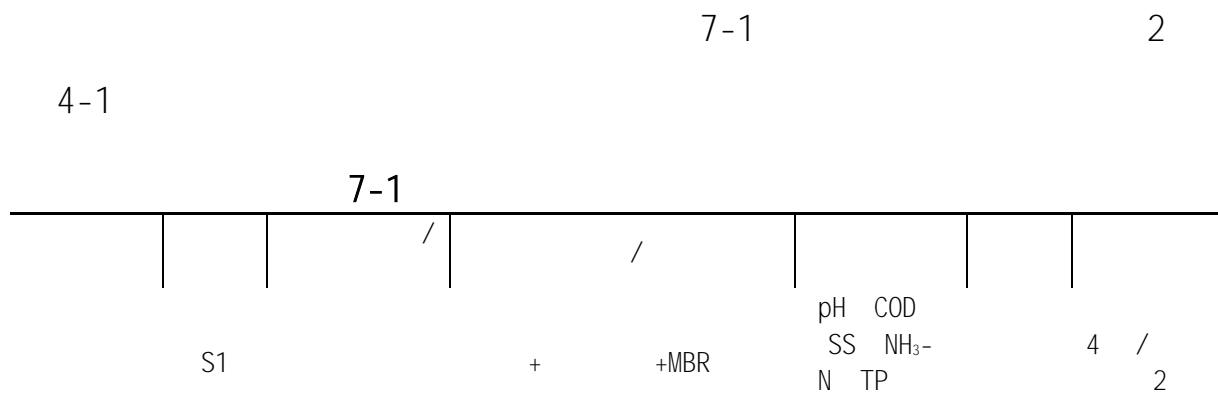

7.2

7.2.1

VOCs

7-2

2

4-2

7-2

		/		/			
--	--	---	--	---	--	--	--

7-3

/

8-5

8. 8.

8.

0.5dB

0.5dB

8. 0B823480)95ETQq0.000071 0 595.32 841.92 reW*nBT/F

8-1

					/
	pH	pH	GB/T6920-1986	/	pH PHB-1 JSGHEL-YQ-112-2
	COD _{Cr}		HJ 828-2017	4 mg/L	50mL JSGHEL-YQ-115-2
	SS		GB/T11901—1989	0.4 mg/L	BSA224S JSGHEL-YQ-102
			HJ 535-2009	0.025 mg/L	UV201 JSGHEL-YQ-38
			GB 11893-1989	0.01 mg/L	UV201 JSGHEL-YQ-38
			HJ 637-2018	0.06 mg/L	JLBG-125 JSGHEL-YQ-35
			HJ/T 33-1999	2 mg/m ³	Trace 1300 JSGHEL-YQ-37
			HJ 549-2016	0.03 mg/m ³	ICS-600 JSGHEL-YQ-135-2
		- / -	HJ 734-2014	0.01mg/m ³	Trace 1300 JSGHEL-YQ-37
	VOCs	- / -	HJ 734-2014	0.001 0.01mg/m ³	Thermo Trace 1300 JSGHEL-YQ-51 YQ3000-C JSGHEL-YQ-160-2
			GB 18483-2001	/	JLBG-125 JSGHEL-YQ-35 YQ3000-C JSGHEL-YQ-160-2 YQ3000-C JSGHEL-YQ-160-3
			GB12348-2008	/	AWA6228 JSGHEL-YQ-121-3

8-2

%

%

8-4

		mg/L	mg/L	
pH	/	/	/	/
CODcr	GSB 07- 3161-2017200197	169± 9	172 164	
	GSB 07- 3161-20172001108	50.7± 3.0	51.8 49.2	
SS	/	/	/	/

9

JSGHEL20192

01 JSGHEL2019201

9.1

2019 3 21 2019 3 22

" "

9.2

9.2.1

9.2.1.1

2019 3 21 2019 3 22

S1

S2 S3

S1

pH7.3

2 7.41 COD_{Cr}167mg/L 5.61mg/L 0.54mg/L 35mg/L

L

9-1

9-1

				(mg/L)	
2019 3 21	S1	pH	7.32		

			(mg/L)		
2019 3 22			0.54	3.0	
			35	400	
			2.10	/	/
	S2	pH	7.51	/	/
		COD _{Cr}	12	/	/
			9	/	/
	S3	pH	7.60	/	/
		COD _{Cr}	16	/	/
			6	/	/
	S4	pH	7.63 7.67	/	/
		COD _{Cr}	4.148× 10 ³	/	/
			0.563	/	/
			0.06	/	/
			84	/	/
	S5	pH	7.44 7.46	/	
		COD _{Cr}	42	/	/
			0.111	/	/
			0.02	/	/
		6	/	/	
S1	pH	7.35 7.43	6 9		
	COD _{Cr}	167	500		
		4.40	35		
		0.47	3.0		
		35	400		
		45.9	/	/	
	S2	pH	7.47	/	/
		COD _{Cr}	14	/	/
			8	/	/

			(mg/L)		
S4	pH	7.56 7.61	/	/	
	COD _{Cr}	2.837× 10 ³	/	/	
		1.36	/	/	
		0.10	/	/	
		75	/	/	
S5	pH	7.42 7.45	/	/	
	COD _{Cr}	40	/	/	
		0.074	/	/	
		0.02	/	/	
		8	/		

2019 3 22

S3

9.2.1.2

2019 3 21

2019 3 22

GB16297-1996 2

GB18483-2001

9-2

9

-3

9-2

1#	2019 3 21	mg/m ³	ND	ND	ND	ND	/	/	
		kg/h	<5.72× 10 ⁻⁴	<5.95× 10 ⁻⁴	<5.60× 10 ⁻⁴	<5.95× 10 ⁻⁴	/	/	
		(mg/m ³)	ND	ND	ND	ND	/	/	
		(kg/h)	<3.81× 10 ⁻²	<3.97× 10 ⁻²	<3.73× 10 ⁻²	<3.97× 10 ⁻²	/	/	
		(mg/m ³)	0.13	0.10	0.05	0.13	/	/	
		(kg/h)	2.42× 10 ⁻³	1.92× 10 ⁻³	9.95× 10 ⁻⁴	2.42× 10 ⁻³	/	/	
		# (mg/m ³)	16.2	24.1	10.1	24.1	/	/	
		# (kg/h)	0.309	0.479	0.188	0.479	/	/	
	Q1		mg/m ³	ND	ND	ND	ND	/	/
			kg/h	<5.41× 10 ⁻⁴	<5.52× 10 ⁻⁴				

2019
3 22



2# 03	3 21	kg/h	$<4.24 \times 10^{-4}$	$<4.18 \times 10^{-4}$	$<4.40 \times 10^{-4}$	$<4.40 \times 10^{-4}$	/	/
		(mg/m ³)	ND	ND	ND	ND	/	/
		(kg/h)	$<2.83 \times 10^{-2}$	$<2.79 \times 10^{-2}$	$<2.94 \times 10^{-2}$	$<2.94 \times 10^{-2}$	/	/
		(mg/m ³)	0.05	0.01	ND	0.05	/	/
		(kg/h)	$<7.06 \times 10^{-4}$	$<2.32 \times 10^{-4}$	$<1.47 \times 10^{-4}$	$<7.06 \times 10^{-4}$	/	/
		[#] (mg/m ³)	0.443	0.509	0.440	0.509	/	/
		[#] (kg/h)	6.27×10^{-3}	7.10×10^{-3}	6.46×10^{-3}	7.10×10^{-3}	/	/
	2019 3 22	mg/m ³	ND	ND	ND	ND	/	/
		kg/h	$<4.12 \times 10^{-4}$	$<4.32 \times 10^{-4}$	$<4.14 \times 10^{-4}$	$<4.32 \times 10^{-4}$	/	/
		(mg/m ³)	ND	ND	ND	ND	/	/
		(kg/h)	$<2.75 \times 10^{-2}$	$<2.88 \times 10^{-2}$	$<2.76 \times 10^{-2}$	$<2.88 \times 10^{-2}$	/	/
		(mg/m ³)	0.08	0.10	0.10	0.10	/	/

--	--	--	--	--	--	--	--	--	--





	09			0.17	0.08	0.17	0.17	0.13	0.14	2.0
--	----	--	--	------	------	------	------	------	------	-----

9.2.1.3

2019 3 21 2019 3 22

59.3dB(A)

GB12348-2008 3

9-4

9-5

9-4

				dB(A)	dB(A)		
2019 3 21	Z1	1		55.5	65		
	Z2	1		59.3	65		
	Z3	1		52.3	65		
	Z4	1		52.3	65		
	Z5	1		52.0	65		
	Z6	1		55.8	65		
2019 3 22	Z1	1		59.1	65		
	Z2	1		56.4	65		
	Z3	1		51.9	65		
	Z4	1		51.9	65		
	Z5	1		51.0	65		
	Z6	1		53.2	65		

9-5

			%	kPa	m/s	
2019 3 21		/	/	/	2.4	
2019 3 22		/	/	/	2.1	

9.2.1.4

1

37120.3t/a COD 6.

20 t/a

1.30t/a

0.21t/a

0.02t/a

9-6

9-6

		mg/L	t/a	t/a	
		/	37120.3	24733	
	COD _{cr}	167	6.20	7.35	
	SS	35	1.30	6.15	
		5.61	0.21	0.36	

		1#	VOCs
61.3%-95.2%	2#	VOCs	17.0%-71.
1% 3#	VOCs	40.4%-80.7%	
	5.56%-55.5%		
		9-7	
	9-8		

9-7

kg/h

2019 3 21

2019 3 22

2019 3 21

2019 3 22

9.2.2.2

2019 3 21 2019 3 22

,

98.6%-99.0%

89.3%-92.9%

80.3%-94.65

66.7%-80%

9-9

9-9

mg/L

2019 3 21	S4	4.148× 10 ³	84	0.563	0.06
	S5	42	6	0.111	0.02
%		99.0	92.9	80.3	66.7
2019 3 22	S4	2.837× 10 ³	75	1.36	0.10
	S5	40	8	0.074	0.02
%		98.6	89.3	94.6	80

10

10.1

" "

10-1

10.4

10.5

10.5.1

10.5.1.1

115m

115m

10.5.1.2

10.5.2

10.5.2.1

2019 1 14

3

1

--	--	--

+ +

2

GB16297-1996) 2

	GB18597-2001)	
5	2	5 1 2 1 3 1
6	(GB12532-90) 15	
7	DB32139-96)	
8	24733t/a, COD 7.35t/a SS 6.15t/a 0.36t/a 0.06t/a, COD 2.47t/a SS 1.73t/a 0.36t/a 0.01t/a, 0.006t/a 0.006t/a 0.08kg/a HCl 0.03kg/a 0.025kg/a	37120.3 NH ₃ -N 0.21 1.3 COD 6.20 0.02 0.020kg/a
10-3 " "		

186671m

1 60000m)

E101 E201 E301

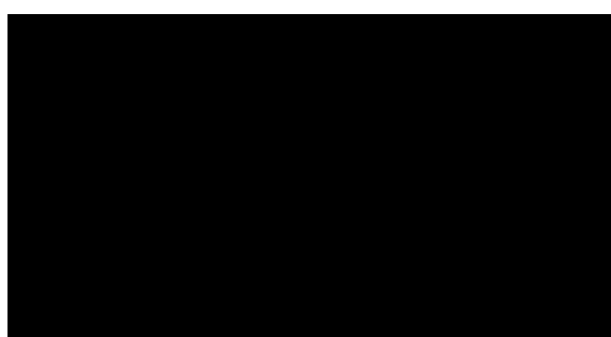

	12.2 m ²)		E301	
	31074m ² ,	7.4 m ²)	20	2016 6
2	"	"	"	"
	+	+MBR		+

8	(GB18597-2001)	(GB18597-2001)
9	50	50
10	([97]122	([97]122
11	24739 COD 7.35 NH ₃ -N 0.36 COD 2.47 NH ₃ -N 0.36	37120.3 COD 6.20 NH ₃ -N 0.21 1.3 0.02

11

11.1

11.1.1

99

186671

90300

935

500

980

15kg

260kg

11.1.2 "

"

2012 9 **8 È**

2012 10 26

2015 5

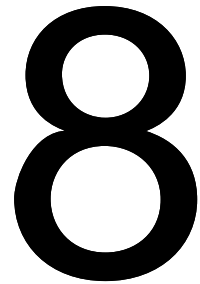

2015 8 4

2013

2015 12

4

11.1.6

1

			S1		p
H7.32	7.41	COD _{Cr} 167mg/L	5.61mg/L	0.54mg/L	35m
g/L					

2

GB16297-1996

2

GB1848

3-2001

3

59.3dB(A)

1

37120.3t/a COD 6.

20 t/a

1.3t/a

0.21t/a

0.02t/a

" "

()

()

()

				/		99
()		C2720			/	118° 88' 65" 32° 14' 05"

500